



TM
VITINNI

12LTR DIGITAL AIR FRYER WITH STAINLESS STEEL TRIM

PLEASE READ AND KEEP THESE INSTRUCTIONS FOR FUTURE USE

MODEL NO: GLA-1003

SAP Code: JF07540002

For further assistance, other products and more, join us at:

Website: www.vitinni.co.uk

Instagram: [@vitinniuk](https://www.instagram.com/vitinniuk)

Facebook: www.facebook.com/vitinni

Thank you for choosing our Vitinni Stainless Steel 12LTR Air Fryer. Please read this user manual carefully and keep it for future reference. The manufacturer and importer do not accept any liability if the information in these operation instructions is not complied with. If you need any assistance, please contact our customer service team on the details provided on the back page of this manual.

Explanations of Symbols



Danger symbols: These symbols indicate risks of injury (e.g. from electricity or fire). Read through the associated safety notices carefully and follow them.



Additional information



Read operating instructions before use.



Caution: hot surfaces!



Suitable for use with food.

Explanation of the Signal Words





DANGER warns of serious injuries and danger to life

WARNING warns of *possible* serious injuries and danger to life

CAUTION warns of slight to moderate injuries

NOTICE warns of material damage

General Safety Instructions

-  **WARNING!** : Read all safety notices, instructions, illustrations and technical data provided with this Air Fryer before using for the first time. Failure to follow the safety notices and instructions may result in electric shock, fire or injuries.
- This Air Fryer is designed for personal use and is not suitable for commercial use.
- Do not use outdoors. Keep away from direct sunlight, heat sources and do not use with wet hands.
- Before cleaning ensure the Air Fryer is switched off and the plug removed from the socket.
-  **Danger:** Do not immerse the power cord, plug or housing in water or under the tap during cleaning.
-  Do not use liquids in the Air Fryer to prevent electric shocks or short-circuit of the Air Fryer.
-  When in use ensure that the air vents of the Air Fryer are not covered.

Warning

- Before using, please ensure that your output voltage is the same voltage as stated on the rating label of the Air Fryer.
- Before use please check the power cord and accessories of the Air Fryer, do not use if there is any damage.
- Ensure the power cord is not hanging over any sharp edges or overhanging the worktop.
- Do not plug in or use the Air Fryer with wet hands.
- Do not use the Air Fryer on a tablecloth or near curtains to avoid the risk of burning.
- When in use do not use an external power cord connection.
- When the Air Fryer is in use do not use plastic dishes, bowls or cling film inside the unit.
- Failure to follow these instructions can result in damage to the appliance and harm to the user. No liability is accepted if these instructions are not followed or if damage results through improper use. Any attempt to alter the appliance or not follow instructions may result in harm and will also void any warranty.
-  The Air Fryer and accessories will become very hot during use. Do not touch heated parts while or after using the Air Fryer! Only touch the handles and control panel while the Air Fryer is in operation or immediately after it has been switched off. Wait until the Air Fryer has cooled down fully before it is transported, cleaned or stored away. Use oven gloves and the removal tool if necessary when handling the hot accessories.

- The Air Fryer should be placed on a stable surface when in use.



- Do not place the Air Fryer against wall or other appliances; ensure there is at least 10cm of space Do not place anything on the top of the Air Fryer.
- Do not use the Air Fryer for anything other than that specified in the operating instructions.
- Do not leave the Air Fryer unattended.



- When the Air Fryer is in use, hot steam will exhaust through the air vents .Keep your hands and face away from the steam and air vents. Also be careful of hot steam when removing food and accessories from the Air Fryer.
- Once the cooking cycle is completed, the heater component will be very hot, do not touch it.
- Do not extend the recommended cooking times as this could lead to the food burning with smoke released from air vent. Unplug the Air Fryer immediately. When safe to do so clean any residual food and oil from the Air Fryer and accessories.
- After using the Air Fryer, press the power button to turn off, and then remove the plug from the socket.
- This Air Fryer can be used by children aged from 8 years and above and persons with reduced physical, sensory or mental capacities or lack of experience or knowledge only if they have been given supervision or instruction concerning use of the appliance in a safe way and understand the hazards involved. Children shall not play with the appliance. Cleaning and user maintenance shall not be made by children without supervision.

Caution

- Unplug the Air Fryer from the wall socket when not in use or before cleaning. Before cleaning ensure the Air Fryer as cooled down.
- Do not use any accessories other than those provided.
- Ensure the accessories are clean and dry before putting the food inside.
- The Air Fryer has a built-in safety switch and will switch to standby mode if the door is opened.
- If the power cord becomes damaged, it must be replaced by the manufacturer, its service agent or a similarly qualified person.
- Keep the Air Fryer and the power cable out of reach of children.
- The Air Fryer must not be operated by means of an external timer or separate remote-control system.
- The door and housing unit of the Air Fryer may get hot when in use.

Risk of Damage to Material and Property

- The Air Fryer should only be connected to a properly installed socket. The socket must be readily accessible so that the connection to the mains can quickly be isolated. The mains voltage must match the technical data of the Air Fryer.
- Do not use any extension cables.
- Unwind the connecting cable fully before connecting up the Air Fryer.
- Remove the mains plug if a fault occurs during operation. Otherwise always switch off the Air Fryer first before the mains plug is pulled out of the plug socket.
- Always pull the mains plug and never the connecting cable when disconnecting the Air Fryer from the mains power. Do not pull or carry the Air Fryer by the connecting cable.
- Always check the Air Fryer for damage before putting it into operation. The Air Fryer should only be used when it is undamaged, and in working order! Do not use the Air Fryer if it has malfunctioned, fallen or been dropped in water.
- Always place the Air Fryer on a dry, even, firm and heat-resistant surface. Never place the Air Fryer on a soft surface. The ventilation slots on the bottom of the Air Fryer must not be covered. Otherwise it could overheat and be damaged.
- Do not place the Air Fryer on or next to heat sources such as hobs or ovens. Keep naked flames, e.g. burning candles, away from the Air Fryer and the connecting cable.
- Do not expose the Air Fryer to extreme temperatures, persistent moisture, direct sunlight or impacts.
- Make sure that the connecting cable is not squashed, bent or laid over sharp edge and does not come into contact with hot surfaces (e.g. of the Air Fryer).
- Never place objects on the Air Fryer or the connecting cable.
- Use only original accessories from the manufacturer in order to guarantee that there is no interference that may prevent the Air Fryer from working and to avoid possible damage.

Intended Use

- This Air Fryer works with hot air and is not a conventional fryer that is filled with oil or deep-frying fat. It is suitable for frying, baking, grilling, drying, keeping warm or de-frosting food. It generally works like a conventional fan oven.
- The Air Fryer is not suitable for preparing or heating liquids such as soups or sauces.
- The Air Fryer should only be used as described in these operating instructions. Any other use is deemed to be improper. Incorrect operation and incorrect handling may cause faults with the Air Fryer and cause injury to the user.
- The following are excluded from the warranty:
 1. All defects caused by improper handling,
 2. Damage or unauthorised attempts at repair.
 3. Normal wear and tear.

Items Supplied

Please check the list of supplied items which correspond to the numbered diagrams below.

1. Air Fryer x 1
 2. Rotating Basket x 1
 3. Rotating Spit Fork with Locking Screw x 2
 4. Shaft of the Rotating Spit x 1
 5. Removal Tool x 1
 6. Baking Rack x 2
 7. Drip Tray x 1
- Operating Instructions x 1

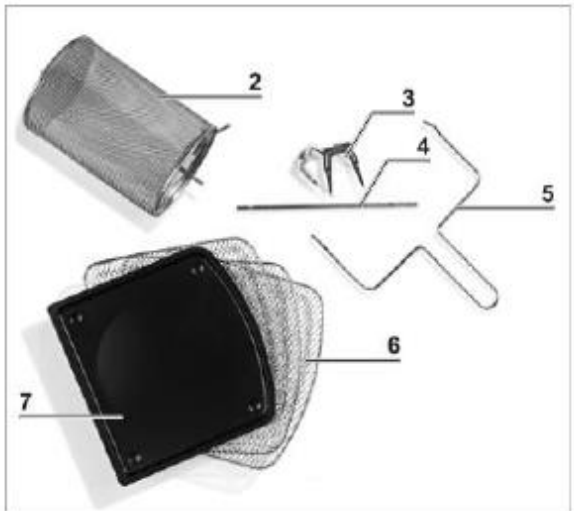





Please ensure that you have received all of the above items and check for any damages before use. If you find any damages, please contact our customer services department before using the Air Fryer.

Remove any possible films, stickers or transport protection from the device before use.

Never remove the rating plate or any warnings!

Air Fryer Overview

8. Heating Element
9. Support for the Shaft and Rotating Basket
10. Cooking Space
11. Holder for the Shaft and the Rotating Basket
12. Rails
13. Lighting
14. Control Panel
15. Display (Alternating display of temperature and remaining cooking time during operation)
16. 10 Program Buttons
17. +/- Increase/Decrease Cooking Time
18.  Rotisserie Function (Rotating Basket, Rotating Spit) ON/OFF
19.  ON/OFF Button
20.  Internal Light Switch ON/OFF
21. +/- Increase/Decrease Temperature
22.  Fan Symbol
23. Air Inlet Slots
24. Air Outlet Openings (on the Back Side)
25. Ventilation Openings (on the Bottom)
26. Door

Please see illustrations overleaf.

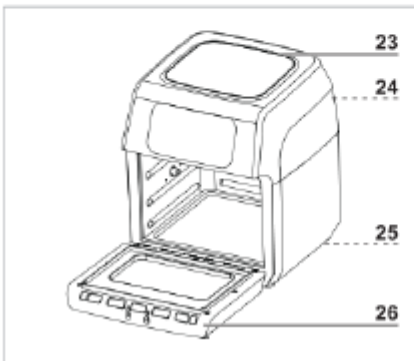
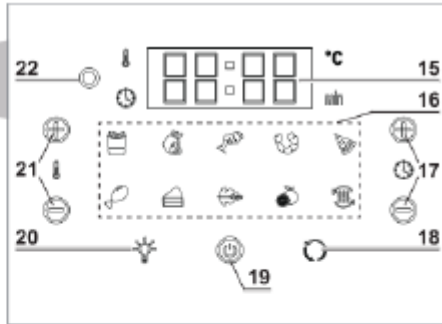
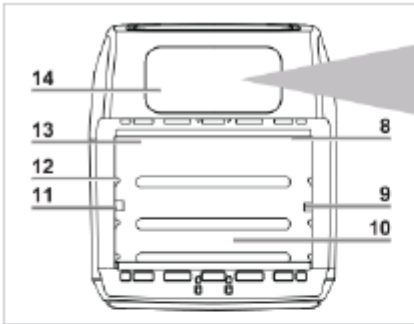

Accessories

Drip Tray

The drip tray (7) should always be inserted so that any dripping fat, crumbs or other food residues can be collected in it. It should be slid right into the bottom of the cooking space (10).

Multi Use Cooking Racks

The cooking racks (6) are intended for dehumidifying. However, they can also be used for crisping, warming up and cooking meat, fish, chicken etc.

The cooking racks are slid onto the rails (12) in the cooking space (10). The heating element (8) is located at the top of the cooking space, i.e. the higher up a cooking rack is placed, and the more intense the heat is from above.

In the top section, the food is cooked faster and crispier. The middle position should be chosen to achieve even heating from all sides. The bottom rails are suitable for gentle cooking.

Rotating Spit

The rotating spit consists of the shaft (4) and two rotating spit forks (3). The rotating spit is suitable for grilling large pieces of meat, e.g. chicken, grilled or roast pork. Use the rotisserie function (18) for even cooking.

Assemble the rotating spit and insert it into the device:

PLEASE NOTE! The shaft contains two small round notches marking the outermost position of the locking screws. These must not be attached any further than the outer ends of the shaft to ensure that smooth operation is possible. Do not place any pieces that are too large onto the rotating spit so that it can rotate without any hindrance.

1. Slide one of the rotating spit forks onto the shaft and lock it with the locking screw. The shaft contains a small round notch for the tip of the locking screw. In the case of smaller pieces of food, the rotating spit forks can be secured more centrally on the shaft
2. Slide the items you want to grill onto the rotating spit fork.
3. Slide the other rotating spit fork onto the shaft and food and lock it with the locking screw.
4. Insert one end of the shaft into the round holder (11) on the left hand side of the cooking space (10). Then hang the other end of the shaft into the support (9) on the right hand side of the cooking space.
5. Check that it fits securely. The rotating spit must not be able to rotate on its own axis when the device is switched off. If this is not the case, insert the left hand end of the shaft deeper into the holder.
6. After use, remove the hot rotating spit from the cooking space using the removal tool (5) (see the "Removal Tool" section). Always use oven gloves to remove the section). Always use oven gloves to remove the rotating spit rotating spit forks and take off forks and take off the grilled items the grilled items

Rotating Basket

In the rotating basket (2), the food is rotated during cooking so that it becomes crispy on all sides. The rotating basket is particularly suitable for preparing chips or other potato products, small pieces of vegetables and meat as well as frozen products, e.g. chicken nuggets or onion rings.

Fill the rotating basket and insert it into the device:

1. Open the flap of the end of rotating basket.
2. Fill the rotating basket no more than $\frac{3}{4}$ full with food. It should not be too full to ensure that the food is cooked evenly.
3. Close the flap and ensure that it is closed correctly so that it does not open during use.

4. First insert the left hand side (marked L) of the rotating basket into the cooking space (10). To do this, insert the left end (with just one notch) of the shaft as far as it will go into the round holder (11) on the left hand side of the cooking space. Then hang the other end (with two notches) of the shaft into the support on the right hand side of the cooking space.

5. Check that it fits securely. The rotating basket must not be able to rotate about its own axis when the Air Fryer is switched off. If this is the case, insert the left hand end of the shaft deeper into the holder. After use, remove the hot rotating basket from the cooking space using the removal tool (see the Removal Tool section). Always use oven gloves to open and empty the rotating basket.

Removal Tool

The hot rotating basket or rotating spit is taken out of the cooking space using the removal tool (5).

1. Place the ends of the removal tool under the shaft as shown in below diagram.



2. First lift up the right hand side of the shaft and move it forwards a little until the left end of the shaft is released from the holder.

3. Carefully lift the rotating basket or rotating spit out of the cooking space (10) and place down on a heat resistant surface.

Before Initial Use

1. The Air Fryer should be used for the first time without any food in it as it may produce some smoke or odours due to coating residues. Allow the device to heat up on the highest temperature setting for approx. 15 minutes without any food in it.

2. Clean all accessories in warm soapy water and dry thoroughly.

Operating the Air Fryer



PLEASE NOTE!

Do not place food that is still packed in plastic wrap or plastic bags in the Air Fryer.

Only ever place the hot accessories on a heat resistant surface.

Make sure that the food does not come into contact with the heating element of the Air Fryer.

Keep the Air Fryer clean. Any dirt and contamination could start to burn and possibly cause faults.



The door (26) of the Air Fryer must be closed for settings to set and to use the functions.

After switching off the Air Fryer, the fan continues to run for a few seconds to cool down the Air Fryer. The fan symbol (22) flashes.

The Air Fryer has overheating protection. It switches off if it is overloaded. In this case, remove the mains plug out of the plug socket and allow the Air Fryer to cool down completely.











1. Place the main unit (1) on the kitchen unit or another dry, clean, flat and non-heated work surface. Ensure that there is sufficient clear space at all sides for ventilation.
2. Completely unwind the connecting cable and plug the mains plug into a plug socket.
3. Open the door.
4. Slide the drip tray (7) into the bottom of the cooking space (10).
5. Select a suitable accessory for the food that is to be prepared (see the "Accessories" chapter). You can also use a small casserole or baking dish and place it on a baking rack (6).
6. Prepare the food and place it on / in the accessory.
7. Attach this accessory in the Air Fryer (see the "Accessories" chapter).
8. Close the door.

9. Press the ON/OFF button (19). The displays on the control panel (19) switch on. 185 °C and 15 minutes are pre-set.

10. Either set the temperature and cooking time manually with the buttons + / (17 and 21) and start the cooking process by pressing the ON/OFF button or select one of the 10 pre-set programmes (16)

Choosing a Programme



Touch the required programme symbol. When it flashes, the programme is activated and the device will turn on a few seconds later. As long as the symbol is flashing, a program change is possible. With the ON/OFF button, the cooking process can be started immediately. The symbols represent the following pre-settings:

Symbol	Programme	Temperature	Cooking time
	Chips/Fries	200 °C	15 min
	Steak/Cutlets	175 °C	25 min
	Fish	165 °C	15 min
	Prawns	160 °C	12 min
	Pizza	180 °C	15 min
	Chicken	185 °C	40 min
	Baking	160 °C	30 min
	Rotary grilling (with automatic rotating function)	190 °C	30 min
	Dehumidifier	30 °C	2h
	Reheat	115 °C	12 min



The temperatures and cooking times which are set for the programmes are merely averages and should be adjusted if necessary. As the ingredients differ due to their origin, size, shape and quality, the actual cooking temperatures and times may vary. Make sure before serving that meat and poultry are thoroughly cooked.

If needed, change the cooking time or temperature of a selected programme with the buttons + / - (17 and 21).

11. If the rotating basket or the rotating spit is used, touch the  button (18) to start the rotating function. (Touching the  button again will stop the rotating function.)



Until you are properly familiar with the Air Fryer, the condition of the food should be checked in between times to ensure that it does not burn. To do this, switch



on the light using the  button (20) or open the door. When the door is opened, operation is interrupted automatically and the light switches on. Operation is resumed once the door is closed.

12. Once the cooking time has elapsed, the Air Fryer switches off automatically and 5 beeps will sound. If the Air Fryer is to be stopped prematurely, press the ON/OFF button.

13. Carefully open the door and take the cooked items out of the Air Fryer. Only ever take out the rotating basket or rotating spit using the removal tool (5).

14. Remove the mains plug from the plug socket after use.

15. Allow the used accessories and Air Fryer to cool down and then clean them (see the "Cleaning" section).

Cleaning



PLEASE NOTE!

Do not use any caustic or abrasive cleaning agents or scouring sponges for cleaning. These may damage the surface.

Clean the main unit (1) and the used accessories after each use to prevent germ formation and burning of food residues. Do not allow food residues to dry on.

1. Do not immerse the main unit in water or other liquids! Do not place them in the dishwasher! If necessary, clean them with a damp cloth and a little detergent.

2. Clean all other used parts with detergent and warm soapy water or in the dishwasher. In the case of stubborn dirt, we recommend soaking the accessories in warm soapy water before putting them in the dish washer.

3. Allow all parts to dry completely or dry them with a tea towel.

Technical Data

- Model number: GLA-1003
- Power supply: 220
- 240 V~ 50/ 60 Hz
- Power: 1800 W
- Protection class I
- Capacity: 12 l
- Timer: Up to 90 minutes;
- Drying programme: up to 24 hours
- Temperature setting: 80 C 200 C

Troubleshooting

If the device does not work properly, first check whether you are able to rectify the problem yourself. If the problem cannot be solved with the following steps, contact the customer service department.



Do not attempt to repair an electrical device yourself!

Problem	Possible cause	Fix
The device does not work. The displays on the control panel do not switch on.	The door is not closed properly.	Close the door.
	The mains plug is not inserted correctly in the plug socket.	Push the mains plug into the plug socket as far as it will go.
	The plug socket is defective.	Try another plug socket.
	No mains voltage is present.	Check the fuse of the electrical distributor (fuse box).
	The overheating protection has been triggered.	Pull the mains plug out of the plug socket and allow the device to cool down completely. Then try again.
The fuse in the electrical distributor (fuse box) is triggered.	Too many devices connected to the same circuit	Reduce the number of devices in the circuit.
The food has not been cooked evenly.	Different items of food with different cooking times have been prepared at the same time.	Place food with a longer cooking time in the device first, then add ingredients with a shorter cooking time later.
	Items of food which require different cooking temperatures have been prepared at the same time.	Prepare items of food with different cooking temperatures one after the other.
	The set cooking time was too short or the temperature too low.	Increase the cooking time or temperature.
	The rotating basket or baking rack is overfilled.	Reduce the amount of food.
	The items of food are piled on top of one another.	Spread the food and mix it around from time to time.
The food is slightly burnt.	The selected temperature is too high or the cooking time too long.	Reduce the temperature or cooking time.
Chips made from fresh potatoes are not crispy.	The potatoes contain too much water.	Cut the potatoes into narrower pieces. Dab the potato pieces dry with some kitchen towel and then trickle a little cooking oil over them.
During use, an unpleasant smell or smoke is detected.	The device is dirty.	Follow the instructions in the "Cleaning" chapter.
	The device is being used for the first time.	A smell often develops when new devices are first used. The smell should disappear once the device has been used several times.
	Too much oil or grease.	Remove excess oil or grease.
Error messages E1 or E2	The sensor is defective.	Contact the customer service department.

Disposal



Dispose of the packaging material in an environmentally friendly manner so that it can be recycled.



The Air Fryer is governed by the European Directive 2012/19/EU on waste electrical and electronic equipment (WEEE). Do not dispose of the Air Fryer as normal domestic waste, but rather in an environmentally friendly manner via an officially approved waste disposal company.

Suggested Recipes

Before you start preparing any food, it is essential to read the “Accessories” and “Operating the Air Fryer” sections to familiarise yourself with the way that the Air Fryer works. This knowledge will then enable you to prepare lots of different dishes following any recipes you want.

The temperatures and cooking times specified in the following suggested recipes are guideline figures. As the ingredients differ due to their origin, size, shape and quality, the settings actually required may vary. It is important to check how the food is cooking from time to time and adjust the temperature or cooking time. Make sure before serving that meat and poultry are thoroughly cooked.

Tips

Shake/turn the food around halfway through the cooking time to make sure it is cooked evenly or crispy.

Generally it is not necessary to preheat the Air Fryer. When preparing food which is to be “ready on the dot”, it is advisable to extend the cooking time by 3 minutes.

Cooking times are dependent on the size and quantity of the food and on the cooking temperature. However, in general the cooking times are shorter than in a conventional oven.

Start with shorter cooking times and then adapt the cooking times to your personal taste.

Generally no oil is required for preparing food. You can add oil to your food to enhance the taste by spraying your food with a little oil from the oil atomiser.

Before the specified cooking time elapses, check whether the food is already cooked through or extra time is required.

Recipes

Home Made Chips

Ingredients

- 4 large potatoes
- 1-2 tbsp. cooking oil
- Salt/Pepper to taste

Method

1. Peel the potatoes and cut them into sticks of equal size. Depending on how thick you cut your potatoes, you can vary between potato wedges and thick or thin chips. The thicker the potatoes are cut, the longer the cooking time.
2. Thoroughly wash the potatoes with cold, clear water to remove any excess starch and then dry them off. The less moisture is present, the crispier the chips will become.
3. Add 1-2 tbsp. of oil to the potatoes and mix together. It is not essential to add oil. However, adding oil will make the chips crispier and give them a more enhanced flavor.
4. Place the sliced potato chips into the rotating basket.
5. Insert the rotating basket into the cooking space.
6. Start the "Chips" programme.
7. Press the "Rotating" button to activate the rotating function.
8. The chips are cooked when they are golden brown. Reduce the temperature if necessary if the chips start to get too dark. If they are not cooked after the end of the programme, extend the cooking time and adjust the temperature if necessary.

Tips

- Mix your favourite herbs and spices into the oil before adding it. This will allow you to prepare tasty curry or paprika flavoured chips.
- Use waxy potatoes. Young potatoes contain more water and therefore take longer to cook and it is possible that they may not go as crispy.
- Pre-boiled potatoes will cook more evenly. Cut the potatoes into small sticks and pre-boil them for around five minutes. This will prevent the chips from being crispy on the outside but not fully cooked on the inside.
- If you want to prepare frozen chips, there is no need to add any oil.

Recipes

Spicy Chicken Legs

Ingredients

- 4-6 chicken legs
- 2-3 tbsp. olive oil
- 1 garlic clove
- 1 tsp. sugar
- 1 tsp. paprika powder
- Salt/Pepper to taste

Method

1. Peel the garlic and squeeze through the garlic press.
2. Mix the clove of garlic with the sugar, paprika powder, salt, pepper and oil.
3. Rub the marinade into the chicken legs and allow it to infuse for at least 20 minutes.
4. Place the chicken legs on the baking rack in the middle position.
5. Start the "Chicken" programme.
6. Check how cooked the chicken legs are in between times. The cooking time may vary depending on the size of the chicken legs. Adjust the temperature and cooking time accordingly if necessary.

Recipes

Chicken Breast Strips in Breadcrumbs

Ingredients

- 2 chicken breast fillets
- 1-2 egg whites
- ½ cup flour for breadcrumbs
- ½ cup breadcrumbs
- ½ tsp. salt
- ½ tsp. pepper

Method

1. Separate off the egg whites.
2. Place the egg whites, flour and breadcrumbs into three separate bowls.
3. Slice each of the chicken breast fillets into strips of equal sizes.
4. Season the chicken breast fillet strips with salt and pepper, roll in the flour, then dip them in egg white and roll in the breadcrumb coating.
5. Place the chicken breast fillet strips onto the baking rack.
6. Insert the baking rack into the middle of the air fryer.
7. Start the “Chicken” programme.
8. Check in between times whether the chicken breast strips are cooked through and reduce or extend the cooking time if necessary.

Recipes

Cod Fillet with Garlic and Herb Crust

Ingredients

- 100g cod fillet
- 1-2 egg whites
- 1 garlic clove
- 1 tbsp. chopped basil
- 1 tsp. paprika powder
- ½ cup breadcrumbs
- Salt & Pepper to taste

Method

1. Peel the garlic and squeeze through a garlic press.
2. Mix together the garlic, the rest of the herbs and the breadcrumbs in a bowl.
3. Separate off the egg white and pour into a separate bowl.
4. Dip the cod fillet in egg white and then coat in the garlic and herb breadcrumb coating.
5. Place the cod fillet on the baking rack.
6. Insert the baking rack into the middle of the air fryer.
7. Start the "Fish" programme.
8. If the cod fillet is not yet cooked, extend the cooking time if necessary.

Recipes

Apple Turnovers

Ingredients

- 1-2 apples
- 1 roll puff pastry
- 50g brown sugar
- 2 tbsp. flour
- 1-2 tbsp. lemon juice

Method

1. Peel the apples, remove the cores and cut them into small pieces.
2. Mix together the pieces of apple, flour, sugar and lemon juice and add cinnamon to taste.
3. Roll out the puff pastry and divide it into pastry squares with an edge approx. 10cm long
4. Spread one tablespoon of the filling in the middle of the pastry squares.
5. Brush a little water onto the edge of the pastry and fold it up into triangles. Firmly press down the edge of the pastry.
6. Spread the apple turnovers on the baking rack.
7. Insert the baking rack into the middle of the air fryer.
8. Start the "Baking" programme.
9. Before the cooking time elapses, check whether the apple turnovers are golden brown and take them out before the end of the cooking time if necessary. If the apple turnovers appear too light, extend the cooking time.

Recipes

Vegan Cup Cakes

Ingredients

- 275g self-raising flour
- 1tsp. baking powder
- 225g caster sugar
- 200ml sunflower oil
- 200ml soya milk
- 1tsp vanilla extract
- Cake cases

Method

1. Mix the flour, baking powder and sugar in a large bowl.
2. Make a well in the centre and add the sunflower oil, soya milk and vanilla. Use a large metal whisk to thoroughly combine all the ingredients.
3. Spoon the batter into the cake cases up to half full (if you do not have a baking tray which fits inside the air fryer, use two cake cases per cake).
4. Insert the cupcakes into the middle/bottom of the air fryer.
5. Start the "Baking" programme.
6. Before the cooking time elapses, check whether the cupcakes are thoroughly cooked and take them out before the end of the cooking time if necessary.

Banana Chips

Ingredients

- Bananas

Method

1. Peel the bananas and cut them into slices 2-3mm thick. The thinner they are, the faster they will dry.
2. Spread the banana slices on the baking racks.
3. Insert the baking rack into the middle of the air fryer.
4. Start the "Drying" programme.
5. Check whether the banana slices are dry. They will feel slightly leathery when they are done. Otherwise start the programme again or increase the cooking time.

Guarantee

Our products are guaranteed for a period of 2 years from the date of purchase. Products that develop a fault within this period are covered by our warranty and we will replace defective parts, or where not available the whole product. The warranty does not apply to any defect in the goods arising from fair wear and tear, wilful damage, accident, negligence by you or any third party, use otherwise than as recommended by us, failure to follow our instructions, any alteration or repair carried out without our approval or has been the subject of commercial use. Your statutory rights remain unaffected, in particular any rights you have under the Consumer Rights Act 2015.

If you have a problem with your product within this warranty period please contact our customer services team.

In the event of changes to the specification of a product and we are not able to replace parts, we will replace the whole product within the 2 year guarantee period

For products that fall outside of the 2 year guarantee, we will endeavour to provide spare parts to purchase for as many of the replaceable parts as possible, but cannot foresee specification changes or upgrades to products or parts outside of the initial 2 year period.

Customer Services:

If you would like further advice or information on your product, ensure you have the SAP code ready and please get in touch with us at Vitinni on the contact options below:

SAP Code: JF07540002

Phone: 01706 716 116 (Mon – Fri 9am to 5pm)

Email: support@vitinni.co.uk

Address: Vitinni, Vale Mill (Rochdale) Ltd, Robinson Street, Rochdale, OL16 1TA